



LITHIUM IRON PHOSPHATE BATTERY

ELECTRICAL SPECIFICATIONS

Nominal Voltage	25.6 V
Nominal Capacity	100 Ah
Capacity @ 25A	240 min
Energy	2560 Wh
Resistance	30 mΩ
Efficiency	99%
Self Discharge	<3% per Month
Maximum Modules in Series	1

DISCHARGE SPECIFICATIONS

Maximum Continuous Discharge Current	100 A
Peak Discharge Current	200 A (7.5 s ±2.5 s)
PCM Discharge Current Cut-Off	280 A (±50 A)
Recommended Low Voltage Disconnect	22 V
PCM Discharge Voltage Cut-Off	16 V
Reconnect Voltage	20 V
Short Circuit Protection	200-600 μs

TEMPERATURE SPECIFICATIONS

Discharge Temperature	-4 to 140 °F (-20 to 60 °C)
Charge Temperature	32 to 131 °F (0 to 55 °C)
Storage Temperature	-4 to 140 °F (-20 to 60 °C)
PCM High Temperature Cut-Off	176 °F (80 °C)

DIMENSIONAL SPECIFICATIONS

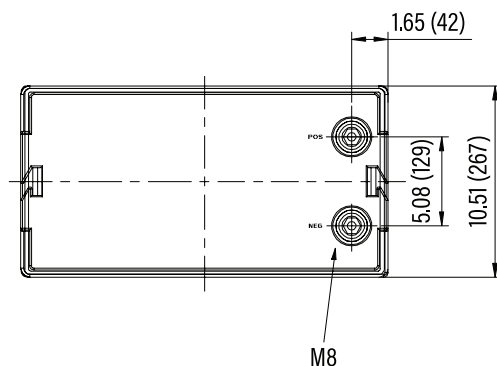

MECHANICAL SPECIFICATIONS

Dimensions (L x W x H)	20.5 x 10.5 x 9.0"
	520 x 267 x 228 mm
Weight	61 lbs (27.7 kg)
Terminal Type	M8
Terminal Torque	80 - 100 in-lbs (9 - 11 N-m)
Case Material	ABS
Enclosure Protection	IP56
Cell Type - Chemistry	Cylindrical - LiFePO ₄

CHARGE SPECIFICATIONS

Recommended Charge Current	50 A
Maximum Charge Current	100 A
PCM Charge Current Cut-Off	280 A (±50 A)
Recommended Charge Voltage	28.4 V - 29.2 V
PCM Charge Voltage Cut-Off	31.2 V
Reconnect Voltage	30.4 V
Balancing Voltage	28.8 V

COMPLIANCE SPECIFICATIONS

Certifications	CE (battery) UL1642 & IEC62133 (cells)
Shipping Classification	UN 3480, CLASS 9

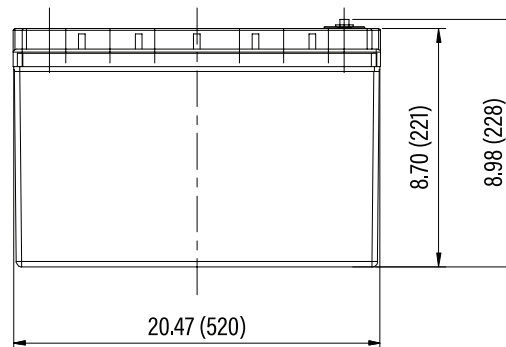



RB24V100

Group: 8D

PERFORMANCE CHARACTERISTICS

DISCHARGE VOLTAGE CHARACTERISTICS at VARIOUS RATES
25°C (77°F)

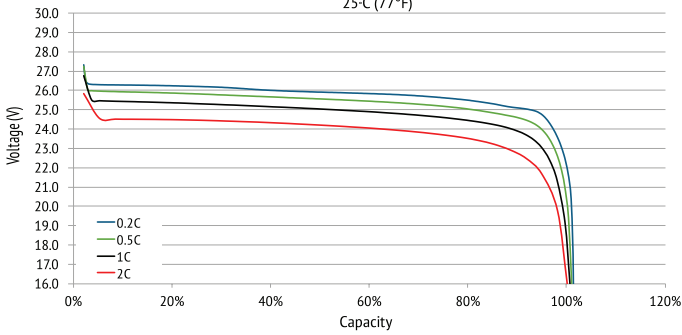

DISCHARGE VOLTAGE CHARACTERISTICS at VARIOUS TEMPERATURES
DISCHARGE 1C

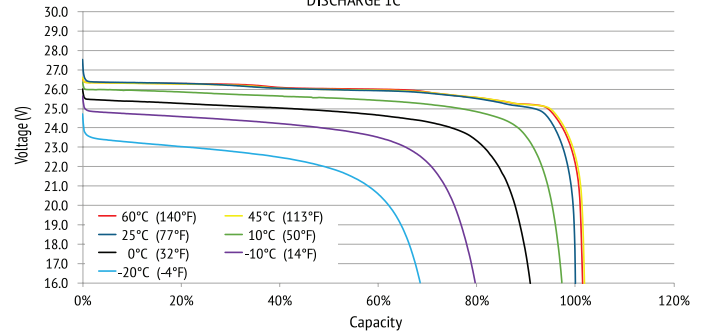

CHARGE VOLTAGE CHARACTERISTICS at VARIOUS TEMPERATURES
CHARGE 0.2C

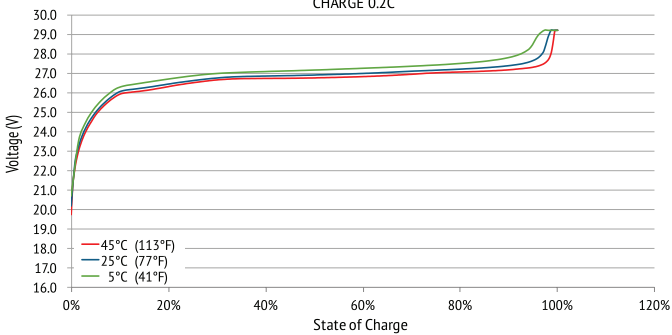

CHARGE VOLTAGE and STATE OF CHARGE (SOC)
CHARGE 0.2C @ 25°C (77°F)

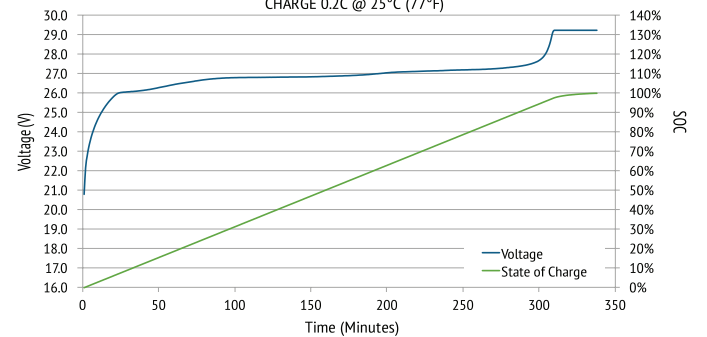

CYCLE LIFE vs. DEPTH OF DISCHARGE (DOD)
DISCHARGE 0.5C/CHARGE 0.5C @ 25°C (77°F)

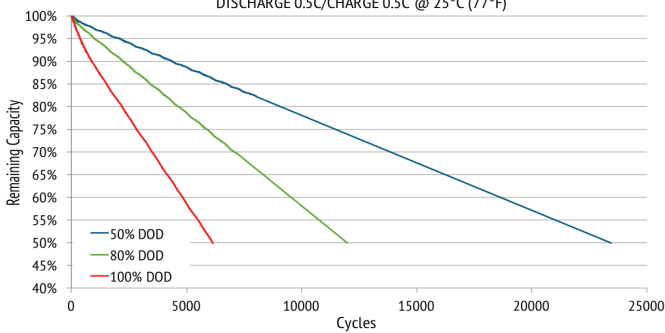

CAPACITY of RELiON LiFePO₄ vs. LEAD ACID
at VARIOUS RATES OF DISCHARGE

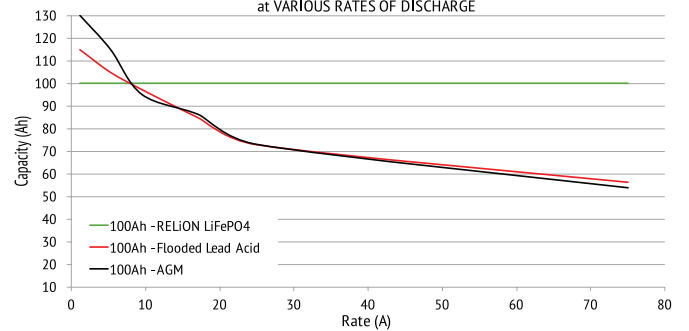

RB24V100DS10.20.2017

